

Course FM/2 Practice Exam 3 – Solutions

Solution 1

D Dedication

Since the only available bonds are zero-coupon bonds, this question is fairly straightforward. The liability at time 3 of \$1,500,000 needs to be matched with enough 3-year bonds to pay this amount at time 3. The number of 3-year bonds needed is:

$$\frac{1,500,000}{1,000} = 1,500$$

The liability at time 2 of \$1,000,000 needs to be matched with 2-year bonds. The number of 2-year bonds needed is:

$$\frac{1,000,000}{1,000} = 1,000$$

The liability at time 1 of \$500,000 needs to be matched with 1-year bonds. The number of 1-year bonds needed is:

$$\frac{500,000}{1,000} = 500$$

To determine the cost to the company to buy these bonds, we need to determine the prices of the three bonds:

$$P_{3-yr} = \frac{1,000}{1.10^3} = 751.31480$$

$$P_{2-yr} = \frac{1,000}{1.09^2} = 841.67999$$

$$P_{1-yr} = \frac{1,000}{1.08} = 925.92593$$

The cost to the company is then:

$$500(925.92593) + 1,000(841.67999) + 1,500(751.31480) = 2,431,615.158$$

Solution 2

B Principal amount in a loan payment

The loan payments form a compound increasing annuity-immediate, the present value of which is:

$$\frac{1}{1+e} a_{\overline{n}|j} = \frac{1}{1+e} \left[\frac{1-(1+j)^{-n}}{j} \right] \text{ where } j = \frac{i-e}{1+e}$$

Since the loan payments and the increases in the loan payments occur quarterly, let's work in quarterly periods. The quarterly effective interest rate is $0.08/4 = 0.02$. There are 40 quarters in 10 years. The interest rate to use with the compound increasing annuity-immediate present value factor is $j = (0.02 - 0.01)/(1.01) = 0.009901$. The first quarterly loan payment P is therefore:

$$P_1 = \frac{50,000}{\frac{1}{1.01} \left(\frac{1 - 1.009901^{-40}}{0.009901} \right)} = 1,535.117884$$

The 11th quarterly loan payment includes 10 quarterly increases of 1%:

$$P_{11} = 1,535.117884(1.01)^{10} = 1,695.72518$$

To determine the amount of interest in the 11th loan payment, we need to determine the loan balance at time 10 quarters. With the retrospective method, the loan balance at any time is the accumulated value of the initial loan amount less the accumulated value of the loan payments up to that point. Assuming the first loan payment was \$1, the present value of the first 10 quarterly loan payments at time 0 is:

$$PV_0 = \frac{1}{1.01} a_{\overline{10}|0.9901\%} = \frac{1}{1.01} \left(\frac{1 - 1.009901^{-10}}{0.009901} \right) = 9.38251$$

Assuming the first loan payment was \$1, the accumulated value at time 10 quarters of the first 10 loan payments is:

$$AV_{10} = 9.38251(1.02)^{10} = 11.43723$$

Notice that we accumulated at the quarterly effective interest rate of 2%. So the loan balance at time 10 quarters is:

$$B_{10} = 50,000(1.02)^{10} - 1,535.117884(11.43723) = 43,392.22551$$

The interest in the 11th loan payment is:

$$I_{11} = 43,392.22551(0.02) = 867.84451$$

The amount of principal in the 11th loan payment is:

$$P_{11} = 1,695.72518 - 867.84451 = 827.88067$$

Solution 3**D** Short sale

Since we have been given per share information, we need to multiply the per share amounts times the number of shares (i.e., 100) to determine the amounts for the entire investment. Using the equation for the yield on a short sale, we solve for the unknown variable, M :

$$SS \text{ yield} = \frac{(S - B) + (\text{margin } i)(\text{margin req \%})(S) - \text{div}}{(\text{margin req \%})(S)}$$

$$0.10 = \frac{(75 \times 100 - 71 \times 100) + 0.05 \times 75 \times 100 \times M - 1.5 \times 100}{75 \times 100 \times M}$$

$$750M = 250 + 375M$$

$$M = 0.667$$

Solution 4**C** Spot and forward rates

The timeline below shows the relationship between spot and forward rates over the first five years and how they are placed on the timeline:

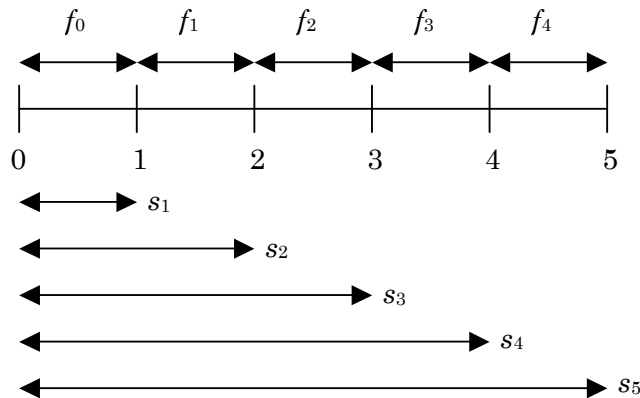

Even though this question instructs us to determine the present value of this annuity two years from now using forward rates, it is quicker to ignore this instruction and to calculate this present value using spot rates. Either way, we get the same answer.

The present value at time 0 of this annuity using spot rates is:

$$PV_0 = \frac{100}{1.06^3} + \frac{100}{1.0675^4} + \frac{100}{1.0725^5} = 231.44012$$

The present value of this annuity at time 2 years using spot rates is:

$$PV_2 = 231.44012(1.0525)^2 = 256.37924$$

Alternatively, we can determine the present value of this annuity at time 2 years using forward rates. Calculating the forward rates for the first five years, we have:

$$f_0 = s_1 = 0.045$$

$$f_1 = \frac{1.0525^2}{1.045^1} - 1 = 0.06005$$

$$f_2 = \frac{1.06^3}{1.0525^2} - 1 = 0.07516$$

$$f_3 = \frac{1.0675^4}{1.06^3} - 1 = 0.09032$$

$$f_4 = \frac{1.0725^5}{1.0675^4} - 1 = 0.09274$$

The present value of this annuity at time 2 years using forward rates is:

$$PV_2 = \frac{100}{1.07516} + \frac{100}{(1.07516)(1.09032)} + \frac{100}{(1.07516)(1.09032)(1.092734)} = 256.37924$$

Solution 5

D Sinking fund total payment



The level annual payment P under the amortization method is:

$$P = \frac{10,000}{a_{\overline{10}|6\%}} = \frac{10,000}{\left(\frac{1 - 1.06^{-10}}{0.06}\right)} = 1,358.67958$$

Immediately after the 5th payment, the loan is converted from the amortization method to the sinking fund method. The initial loan balance under the sinking fund method is the balance at time 5 under the amortization method:

$$\begin{aligned} B_5 &= 10,000(1.06)^{10} - 1,358.67958s_{\overline{5}|6\%} \\ &= 13,382.25578 - 1,358.67958\left(\frac{1.06^5 - 1}{0.06}\right) \\ &= 5,723.25267 \end{aligned}$$

Under the sinking fund method, the total annual payment on the loan consists of the service payment to the lender plus the sinking fund payment:

$$\begin{aligned} SP &= 5,723.25267 \times 0.07 = 400.62769 \\ SFP &= \frac{5,723.25267}{s_{\overline{5}|9\%}} = \frac{5,723.25297}{\left(\frac{1.09^5 - 1}{0.09}\right)} = 956.31235 \end{aligned}$$

The total annual payment is:

$$400.62769 + 956.31235 = 1,356.94004$$

Solution 6

D Commodity swap 

We can determine the spot rates from the zero-coupon bond prices:

$$s_1 = \frac{1,000}{952.38} - 1 = 0.05$$

$$s_2 = \left(\frac{1,000}{898.45} \right)^{(1/2)} - 1 = 0.055$$

$$s_3 = \left(\frac{1,000}{839.62} \right)^{(1/3)} - 1 = 0.06$$

The present value at time 0 of the cost per two barrels (one at time 2 year and one at time 3 years) is:

$$PV = \frac{110}{1.055^2} + \frac{125}{1.06^3} = 203.78218$$

The two-year per barrel swap price beginning in one year is determined by solving for X in the equation of value:

$$203.78218 = \frac{X}{1.055^2} + \frac{X}{1.06^3}$$

$$1.73807X = 203.78218$$

$$X = 117.246$$

Alternatively, we can determine this swap price a little more quickly and directly by using the bond prices instead of the spot rates:

$$\frac{110 \times 898.45 + 125 \times 839.62}{898.45 + 839.62} = 117.246$$

Solution 7

A Reinvestment of interest at different rate than initially earned 

At the end of the first year, the time 0 \$5,000 investment pays interest of $5,000 \times 0.08 = 400$. This is then reinvested at an annual effective interest rate of 5% for 19 years until time 20.

At time 1, the account contains the \$5,000 deposit from time 0 plus a new \$5,000 deposit at time 1. So and the end of the second year, the two \$5,000 deposits pay interest of $2 \times 5,000 \times 0.08 = 2 \times 400$. This is then reinvested at an annual effective interest rate of 5% for 18 years until time 20.

At time 2, the account contains the two prior \$5,000 deposits plus a new \$5,000 deposit at time 2. So at the end of the third year, the three \$5,000 deposits pay interest of $3 \times 5,000 \times 0.08 = 3 \times 400$. This is then reinvested at an annual effective interest rate of 5% for 17 years until time 20.

Recognizing a pattern, we can now write the equation of value for the accumulated value at time 20, which includes the 20 deposits of \$5,000 and the interest which is reinvested at a different rate than it was initially earned:

$$20 \times 5,000 + 400(1.05)^{19} + 2 \times 400(1.05)^{18} + 3 \times 400(1.05)^{17} + \dots + 20 \times 400(1.05)^0$$

Rearranging the terms, we recognize the pattern for the accumulated value of an increasing annuity-immediate:

$$100,000 + 400[1 \times (1.05)^{19} + 2 \times (1.05)^{18} + 3 \times (1.05)^{17} + \dots + 20 \times (1.05)^0]$$

The part in the brackets is $(Is)_{\overline{20}|5\%}$. Calculating this required value, we have:

$$(Is)_{\overline{20}|5\%} = \frac{\ddot{s}_{\overline{20}|5\%} - 20}{0.05} = \frac{\left(\frac{1.05^{20} - 1}{0.05/1.05}\right) - 20}{0.05} = 294.38504$$

The accumulated value at time 20 years is then:

$$100,000 + 400[294.38504] = 217,754.0145$$

Solution 8

E Annuity-due accumulated value factor



The cost of the kitchen remodel in 15 years will be:

$$15,000(1.025)^{15} = 21,724.47250$$

Ann deposits \$750 into an account at the beginning of each year for 8 years, the first of which occurs at time 0 and the last of which occurs at time 7 years. The accumulated value of these deposits at time 8 years is:

$$AV_8 = 750\ddot{s}_{\overline{8}|5\%} = 750 \frac{1.05^8 - 1}{0.05/1.05} = 7,519.92324$$

The accumulated value of these deposits at time 15 years is:

$$AV_{15} = 7,519.92324(1.05)^7 = 10,581.28717$$

Ann also deposits $\$X$ at the beginning of years 9, 10, 11 and 12. The beginning of the 9th year is at time 8 years, and the last of the 4 deposits of $\$X$ occurs at time 11 years. The accumulated value of these deposits at time 12 years is:

$$AV_{12} = X\ddot{s}_{\overline{4}|5\%} = X \left(\frac{1.05^4 - 1}{0.05/1.05} \right) = 4.52563X$$

The accumulated value of these deposits at time 15 years is:

$$AV_{15} = 4.52563X(1.05)^3 = 5.23898X$$

Since all of the pieces are valued at time 15 years, we can put them together in an equation of value and solve for the unknown deposit of X :

$$\begin{aligned} 10,581.28717 + 5.23898X &= 21,724.47250 \\ X &= 2,126.97454 \end{aligned}$$

Solution 9

C Nominal rates of interest and discount



The accumulated value of account A at time 15 years is:

$$AV(A)_{15} = 200 \left(1 + \frac{i^{(12)}}{12} \right)^{12 \times 15}$$

Account B credits interest at a discount rate that is compounded every four months, which means interest is compounded three times a year, so $d^{(3)} = 9\%$. The accumulated value of account B at time 15 years is:

$$AV(B)_{15} = 250 \left(1 - \frac{d^{(3)}}{3} \right)^{-3 \times 15}$$

Since each value is determined at time 15 years, we can set up the equation of value and solve for the unknown interest rate:

$$1,284.81 = 200 \left(1 + \frac{i^{(12)}}{12}\right)^{180} + 250 \left(1 - \frac{0.09}{3}\right)^{-30}$$

$$1,284.81 = 200 \left(1 + \frac{i^{(12)}}{12}\right)^{180} + 623.43041$$

$$\left(1 + \frac{i^{(12)}}{12}\right)^{180} = 3.30690$$

$$\left(1 + \frac{i^{(12)}}{12}\right) = 1.00667$$

$$i^{(12)} = 0.080$$

Solution 10

B Macaulay duration of bond



The formula for Macaulay duration is:

$$MacD = \frac{\sum tCF_t \left(1 + \frac{y}{m}\right)^{-mt}}{\sum CF_t \left(1 + \frac{y}{m}\right)^{-mt}}$$

The bond pays annual coupons of \$X at the end of years one through ten, and it also pays its par value of \$100 at time ten years. Working with the information we have about this bond, its Macaulay duration is:

$$MacD = \frac{1 \times X(1.10)^{-1} + 2 \times X(1.10)^{-2} + \dots + 10 \times X(1.10)^{-10} + 10 \times 100(1.10)^{-10}}{X(1.10)^{-1} + X(1.10)^{-2} + \dots + X(1.10)^{-10} + 100(1.10)^{-10}}$$

$$6.96 = \frac{X(Ia)_{\overline{10}|10\%} + 10 \times 100(1.10)^{-10}}{Xa_{\overline{10}|10\%} + 100(1.10)^{-10}}$$

Calculating the required values, we have:

$$a_{\overline{10}|10\%} = \frac{1 - 1.10^{-10}}{0.10} = 6.14457$$

$$\ddot{a}_{\overline{10}|10\%} = 1.10 \times 6.14457 = 6.75902$$

$$(Ia)_{\overline{10}|10\%} = \frac{6.75902 - 10(1.10)^{-10}}{0.10} = 29.03591$$

Returning to the equation of value, we solve for X :

$$6.96 = \frac{X(29.03591) + 385.54329}{X(6.14457) + 38.55433}$$

$$42.76619X + 268.33813 = 29.03590X + 385.54329$$

$$13.73028X = 117.20516$$

$$X = 8.5363$$

Solution 11

A Varying force of interest



The accumulated value at time 8 years is:

$$AV_8 = Xe^{\int_0^5 0.025s ds} e^{\int_5^8 0.125 ds}$$

$$5,469.03 = Xe^{\left. \begin{matrix} (0.025s^2)/2 \\ 0 \end{matrix} \right|_0^5} e^{\left. \begin{matrix} 0.125s \\ 5 \end{matrix} \right|_5^8}$$

$$5,469.03 = Xe^{0.0125(25-0)} e^{0.125(8-5)}$$

$$5,469.03 = Xe^{0.3125} e^{0.375}$$

$$5,469.03 = Xe^{0.6875}$$

$$X = 2,750.001$$

Solution 12

C Stock price with compound increasing dividends

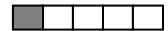

We have a very simple equation for a stock price with compound increasing dividends, and the information from this question matches the pattern expected from the formula, so we can use it in this case. The only unknown is the rate at which the dividends grow, g , so we set up the equation of value and solve for g :

$$P = \frac{div_1}{r - g}$$

$$50 = \frac{4.00}{0.10 - g}$$

$$12.50 = \frac{1}{0.10 - g}$$

$$0.08 = 0.10 - g$$

$$g = 0.02$$

Solution 13**C** Hedging 

Answer choice C is given as a reason why firms might elect to hedge. All the other answer choices are given as reasons why firms might not elect to hedge. See pages 105-106 in the Derivatives Markets text.

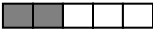
Solution 14**A** Mutual fund investment 

Using the logic from the old adage, “buy low and sell high,” we can quickly determine the answer. If a withdrawal occurs at the same time for two strategies, the best strategy has the deposit at the time of the lowest purchase price. Similarly, if a deposit occurs at the same time, the best strategy has the withdrawal at the time of the highest sale price. Using these two principles, it is a quick series of comparisons to see that choice A is the correct answer.

To verify this result, we recognize that the maximum number of shares at the end of the year will result in the highest fund balance at that time. The number of shares at the end of the year is:

$$1,000 + \frac{500}{\text{Purchase Price}} - \frac{1,500}{\text{Sale Price}}$$

For choice A, we have:

$$1,000 + \frac{500}{4.75} - \frac{1,500}{5.25} = 819.5489 \text{ shares}$$

For choice B, we have:

$$1,000 + \frac{500}{5.05} - \frac{1,500}{5.25} = 813.2956 \text{ shares}$$

For choice C, we have:

$$1,000 + \frac{500}{5.05} - \frac{1,500}{4.75} = 783.2204 \text{ shares}$$

For choice D, we have:

$$1,000 + \frac{500}{5.25} - \frac{1,500}{5.05} = 798.2084 \text{ shares}$$

For choice E, we have:

$$1,000 + \frac{500}{4.75} - \frac{1,500}{5.05} = 808.2335 \text{ shares}$$

Answer choice A provides the maximum fund balance at the end of the year.

Solution 15**E** Dollar and time-weighted interest rates 

This question contains a slight twist in that the fund values in the middle of the year are immediately after a deposit was made. The time-weighted interest rate equation requires the fund values immediately before a deposit was made, so we need to adjust for this before we can use the formula.

Let's denote i as the annual effective interest rate. The equation of value for the dollar-weighted interest rate is:

$$78 = 50(1+i)^{12/12} + 10(1+i)^{(12-3)/12} - 20(1+i)^{(12-7)/12} + 30(1+i)^{(12-11)/12}$$

Since this activity occurs during a 12-month period, we can use the simple interest approximation to solve for the annual effective rate i :

$$78 = 50\left(1 + \frac{12}{12}i\right) + 10\left(1 + \frac{9}{12}i\right) - 20\left(1 + \frac{5}{12}i\right) + 30\left(1 + \frac{1}{12}i\right)$$

$$78 = 50 + 50i + 10 + 7.5i - 20 - 8.3333i + 30 + 2.5i$$

$$51.6667i = 8$$

$$i = 0.1548$$

For the time-weighted interest rates, we need to determine the fund values just before each deposit. We have:

$$F_0 = 50, \quad F_1 = 64 - 10 = 54, \quad F_2 = 46 + 20 = 66, \quad F_3 = 80 - 30 = 50, \quad F_4 = 78$$

The equation of value for the annual time-weighted interest rate is then:

$$(1+y)^1 = \left(\frac{54}{50}\right)\left(\frac{66}{54+10}\right)\left(\frac{50}{66-20}\right)\left(\frac{78}{50+30}\right)$$

$$1+y = 1.18033$$

$$y = 0.1803$$

We have:

$$y - x = 0.180 - 0.155 = 0.025$$

Solution 16**B** Increasing annuity-due and level perpetuity-due 

This series of payments can be split into two parts: an increasing annuity-due and a level perpetuity-immediate. The increasing annuity-due has a payment of \$10 today, \$20 in one year, \$30 in two years, and so on, up to \$100 at time 9 years. The present value of this increasing annuity-due is:

$$10(I\ddot{a})_{\overline{10}|5.5\%}$$

The level perpetuity-immediate has its first payment of \$100 at time 10, and each subsequent annual payment is also \$100. The present value of the level perpetuity-immediate at time 9 years, one year before its first payment, is:

$$100a_{\infty|5.5\%}$$

Calculating the required values, we have:

$$\begin{aligned} \ddot{a}_{10|5.5\%} &= \frac{1 - 1.055^{-10}}{0.055/1.055} = 7.95220 \\ (I\ddot{a})_{10|5.5\%} &= \frac{7.95220 - 10(1.055)^{-10}}{0.055/1.055} = 40.24133 \\ a_{\infty|5.5\%} &= \frac{1}{0.055} = 18.18182 \end{aligned}$$

The present value of the perpetuity-immediate should be discounted for 9 years to bring its value back to time 0. The present value at time 0 of this series of payments is:

$$10(40.24133) + 100(1.055)^{-9}(18.18182) = 1,525.3756$$

Solution 17

A Short ratio hedge 

Answer choice A depicts a short ratio hedge, which is the strategy that Mary Ellen employed. Answer choice B illustrates a long ratio hedge.

Answer choice C shows a purchased collar, while answer choice D depicts a short collar.

Answer choice E shows a bull spread.

Solution 18

E Perpetuity-immediate and annuity-immediate present values 

Since Tom receives the first n annual payments of \$ X , his present value at time 0 is:

$$Xa_{n|6.5\%}$$

Cindy's first payment of X occurs at time $n + 1$, and she then receives payments of \$ X at the end of each year forever. The perpetuity-immediate present value factor is valued one period before the first payment, so it is valued at time n . This present value needs to be discounted back n years to determine its value at time 0. Cindy's present value at time 0 is:

$$Xv^n a_{\infty|6.5\%}$$

We want to determine the time n such that Tom and Cindy each get half of the total present value of the payments. Since their present values have each been determined at time 0, we can equate them and solve for the unknown time n :

$$\begin{aligned} Xa_{\overline{n}|} &= Xv^n a_{\overline{\infty}|} \\ \frac{1 - (1+i)^{-n}}{i} &= \frac{(1+i)^{-n}}{i} \\ 1 - (1+i)^{-n} &= (1+i)^{-n} \\ 2(1+i)^{-n} &= 1 \\ 1.065^{-n} &= 0.5 \\ n &= \frac{\ln(2)}{\ln(1.065)} \\ n &= 11.0067 \end{aligned}$$

Solution 19

B Cost of carry 

The cost of carry is the forward price less the spot price. The forward price is the spot rate of the asset plus the interest cost to carry the asset less the asset's lease rate. In the case of an asset that pays dividends, the asset lease rate is the dividend.

To determine the forward price, we accumulate the current price of the asset with interest over the six-month period at the annual effective rate of 10% and we subtract out (i.e., discount) this amount by the continuously paid asset lease rate of 5% over the six-month period. The forward price is:

$$100(1.10)^{0.5} e^{-0.5 \times 0.05} = 102.2914$$

Since the spot price is \$100, the cost of carry is:

$$102.2914 - 100 = 2.2914$$

Alternatively, since the dividend rate is already expressed as a continuously compounded rate, we could convert the annual effective risk-free interest rate to an annual continuously compounded rate:

$$\delta = \ln(1.10) = 0.095310$$

The cost to carry over 6 months (per dollar) is:

$$e^{(0.095310 - 0.05)0.5} - 1 = 0.022914$$

The cost to carry in dollars is then $100(0.022914) = 2.29$.

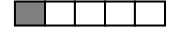
Solution 20**C** Force of interest

Wally's account must also double in n years, so it has a value of \$2,000 at time n . At time $n - 1$, its value is:

$$2,000e^{-0.0693} = 1,866.09345$$

Interest earned in the final year is then:

$$1,866.09345(e^{0.0693} - 1) = 133.9066$$

Alternatively, we can determine n from Ron's information. We are told that Ron's account doubles in value over n years at a level force of interest of 6.93%. We set up the equation of value and solve for n :

$$Xe^{0.0693n} = 2X$$

$$e^{0.0693n} = 2$$

$$n = \frac{\ln(2)}{0.0693}$$

$$n = 10.00212$$

There are a couple of ways to determine the amount of interest earned in Wally's account during the tenth year, which occurs from time 9 years to time 10 years. The first is to determine Wally's account balances at times 9 years and 10 years, subtract the former from the latter, and the result is the amount of interest earned over this time:

$$B_9 = 1,000e^{0.0693 \times 9} = 1,865.81882$$

$$B_{10} = 1,000e^{0.0693 \times 10} = 1,999.70566$$

$$B_{10} - B_9 = 1,999.70566 - 1,865.81882 = 133.8868$$

The second approach is to multiply the time 9 account balance by the annual effective interest rate, which equals $i = e^\delta - 1$:

$$1,865.81882(e^{0.0693} - 1) = 133.8868$$

The difference between the two answers is due to the rounding embedded in the given information.

Solution 21**B** Continuously increasing and decreasing payments

The continuously paid, continuously increasing annuity from time 0 to time 5 fits the payment pattern of $50(\bar{I}\bar{a})_{\overline{5}|}$ since $(\bar{I}\bar{a})_{\overline{5}|}$ expects a payment of t .

The continuously paid, continuously decreasing annuity from time 5 to time 15 fits the payment pattern of $25(\bar{D}\bar{a})_{\overline{10}|}$ since $(\bar{D}\bar{a})_{\overline{10}|}$ expects a payment of $10 - t$. Ignoring the factor of 25 for the moment, we have a payment of $(15 - 5) = 10$ at time 5 which decreases continuously to $(15 - 15) = 0$ at time 15. This present value is determined at time 5, so we need to discount it for 5 years to determine its time 0 present value.

The present value of the entire payment stream is:

$$PV_0 = 50(\bar{I}\bar{a})_{\overline{5}|} + 25(1.15)^{-5}(\bar{D}\bar{a})_{\overline{10}|}$$

Calculating the required values, we have:

$$\begin{aligned}\delta &= \ln(1.15) = 0.13976 \\ \bar{a}_{\overline{5}|} &= \frac{1 - 1.15^{-5}}{0.13976} = 3.59771 \\ \bar{a}_{\overline{10}|} &= \frac{1 - 1.15^{-10}}{0.13976} = 5.38641 \\ (\bar{I}\bar{a})_{\overline{5}|} &= \frac{\bar{a}_{\overline{5}|} - 5(1.15)^{-5}}{0.13976} = 7.95516 \\ (\bar{D}\bar{a})_{\overline{10}|} &= \frac{n - \bar{a}_{\overline{10}|}}{0.13976} = 33.01034\end{aligned}$$

The present value of the entire payment stream is:

$$PV_0 = 50(7.95516) + 25(1.15)^{-5}(33.01034) = 808.0573$$

Solution 22

D Level perpetuity-due and increasing annuity-immediate



The present value of a monthly payment perpetuity-due is just the level payment divided by the monthly effective discount rate. We can determine the monthly effective discount and the corresponding monthly effective interest rate from Bart's perpetuity-due:

$$\begin{aligned}67,666.67 &= \frac{1,000}{d^{(12)}/12} \\ \frac{d^{(12)}}{12} &= 0.014778 \\ \frac{i^{(12)}}{12} &= \frac{d^{(12)}/12}{1 - d^{(12)}/12} = \frac{0.014778}{1 - 0.014778} = 0.015\end{aligned}$$

Lisa's first payment at time one month is $\$X$, and each subsequent payment increases by $\$10$ each month, so that the last payment of $\$X + 230$ occurs at time 24 months. Let's split this payment stream into two parts so that it better fits the patterns expected by the annuity factors. Let's assume the first part consists of level monthly payments of $\$(X - 10)$ that start in one month and ends at 24 months. This leaves the second part, which consists of a payment of $\$10$ at time 1 month, $\$20$ at time 2 months, and so on, up to $\$240$ at time 24 months. The present value of both parts is then:

$$PV_0 = (X - 10)a_{\overline{24}|1.5\%} + 10(Ia)_{\overline{24}|1.5\%} = 67,666.67$$

Calculating the required values, we have:

$$a_{\overline{24}|1.5\%} = \frac{1 - 1.015^{-24}}{0.015} = 20.03041$$

$$\ddot{a}_{\overline{24}|1.5\%} = 1.015 \times 20.03041 = 20.33086$$

$$(Ia)_{\overline{24}|1.5\%} = \frac{20.33086 - 24(1.015)^{-24}}{0.015} = 236.12049$$

We go back to the present value of both parts and solve for X :

$$67,666.67 = (X - 10)a_{\overline{24}|1.5\%} + 10(Ia)_{\overline{24}|1.5\%}$$

$$67,666.67 = (X - 10)(20.03041) + 10(236.12049)$$

$$67,666.67 = 20.03041X - 200.30405 + 2,361.20492$$

$$20.03041X = 65,505.76913$$

$$X = 3,270.3167$$

Solution 23

C Bond price between coupon payment dates



Coupons are paid on June 1 and December 1 of each year. The last coupon that was paid occurred on June 1, 2007, so we first need to determine the price as of the last coupon date. At 6/1/07, there are $(2030 - 2007) \times 2 + 1 = 47$ coupons to be paid before the bond matures on 12/1/30.

Working in semiannual periods, let's define the bond variables:

$$F = C = 1,000$$

$$n = 47$$

$$r = 0.08/2 = 0.04$$

$$\text{coupon} = 0.04 \times 1,000 = 40$$

$$i = 0.06/2 = 0.03$$

The price of the bond as of 6/1/07 is:

$$\begin{aligned} P_{6/1/07} &= 40a_{\overline{47}|3\%} + 1,000(1.03)^{-47} \\ &= 40 \frac{1 - 1.03^{-47}}{0.03} + 1,000(1.03)^{-47} \\ &= 1,250.24708 \end{aligned}$$

We could have determined this bond price with a financial calculator. Using the BA-35 calculator, we press [2nd][CMR], 1,000 [FV], 40 [PMT], 3 [%i], 47 [N], and [CPT][PV], and the result is 1,250.24708. Using the BA II Plus, we press [2nd][CLR TVM], -1,000 [FV], -40 [PMT], 3 [%i], 47 [N], and [CPT][PV], and the result is the same.

To determine the purchase price of the bond at 10/15/07, we need to calculate k , the ratio of the number of days from June 1 – October 15 to the number of days from June 1 – December 1:

$$\begin{aligned} \# \text{ days from 6/1 to 10/15} &= 287 - 152 = 135 \\ \# \text{ days from 6/1 to 12/1} &= 334 - 152 = 182 \\ k &= 135/182 = 0.74176 \end{aligned}$$

The purchase price (inclusive of accrued interest) of the bond at 10/15/07 is:

$$P_{10/15/07} = 1,250.24708(1 + 0.03)^{0.74176} = 1,277.9621$$

This purchase price includes the accrued interest, which is:

$$AI = \text{coupon} \times k = 40 \times 0.74176 = 29.6703$$

The clean price is then:

$$P_{10/15/07} - AI = 1,277.9621 - 29.6703 = 1,248.2917$$

Solution 24

B Cash flow matching / dedication



At the end of year two, the two-year bond will mature for its face amount and pay a coupon that is equal to 7% of its face amount. The insurance company must equate those payoffs from the two-year bond to its \$50,000 obligation at the end of the second year in order to match the cash flows exactly. If we let F_2 be the face amount of the two-year bond, the equation of value is:

$$\begin{aligned} F_2 + 0.07F_2 &= 50,000 \\ F_2 &= \frac{50,000}{1.07} = 46,728.97196 \end{aligned}$$

The price of the two-year bond is:

$$46,728.97196 \left[\frac{0.07}{1.08} + \frac{1.07}{1.08^2} \right] = 45,895.67068$$

At the end of the first year, the two-year bond will make its coupon payment. The one-year bond will mature for its face amount and pay a coupon equal to 5% of its face amount. The insurance company must equate the payoffs from both the one-year and two-year bonds to its \$50,000 at the end of the first year in order to match its cash flows exactly. If we let F_1 be the face amount of the one-year bond, the equation of value is:

$$\begin{aligned} 0.07F_2 + F_1 + 0.05F_1 &= 50,000 \\ 0.07 \times 46,728.97196 + F_1 + 0.05F_1 &= 50,000 \\ F_1 &= \frac{50,000 - 3,271.02804}{1.05} = 44,503.78282 \end{aligned}$$

The price of the one-year bond is:

$$44,503.78282 \left[\frac{1.05}{1.04} \right] = 44,931.70381$$

The insurance company must pay \$90,827 to purchase both the one-year and two-year bonds:

$$X = 44,931.70381 + 45,895.67068 = 90,827.37449$$

A quicker way to determine the answer is to recognize that cash flows that occur at time one year are discounted at the one-year spot rate and cash flows that occur at time two years are discounted at the two-year spot rate. Working with the two-year bond cash flows with a yield of 8%, the one-year spot rate is 4% and we can solve for the two-year spot rate:

$$\begin{aligned} \frac{7}{1.08} + \frac{107}{1.08^2} &= \frac{7}{1.04} + \frac{107}{(1+s_2)^2} \\ (1+s_2)^2 &= 1.169578 \end{aligned}$$

Now it is a simple matter to discount the insurance company's \$50,000 obligation at time one at the one-year spot rate and its \$50,000 obligation at time two at the two-year spot rate:

$$\frac{50,000}{1.04} + \frac{50,000}{(1+s_2)^2} = \frac{50,000}{1.04} + \frac{50,000}{1.169578} = 90,827.37$$

Solution 25**B** Nominal rates of interest and discount 

We set up the equation of value and solve for the unknown annual nominal rate of interest convertible every other year:

$$\begin{aligned} \left(1 + \frac{i^{(1/2)}}{1/2}\right)^{1/2} &= \left(1 - \frac{d^{(2)}}{2}\right)^{-2} \\ \left(1 + \frac{i^{(1/2)}}{1/2}\right)^{1/2} &= \left(1 - \frac{0.1025}{2}\right)^{-2} \\ \left(1 + \frac{i^{(1/2)}}{1/2}\right)^{1/2} &= 0.94875^{-2} \\ \left(1 + \frac{i^{(1/2)}}{1/2}\right)^{1/2} &= 1.11095 \\ 1 + \frac{i^{(1/2)}}{1/2} &= 1.23422 \\ \frac{i^{(1/2)}}{1/2} &= 0.23422 \\ i^{(1/2)} &= 0.11711 \end{aligned}$$

Solution 26**C** Amount of interest in a loan payment 

Since the loan payments occur monthly, let's work in monthly periods. The monthly effective interest rate is:

$$\frac{i^{(12)}}{12} = \frac{0.12}{12} = 0.01$$

To determine the amount of interest in the 25th payment, we need to determine the loan balance at time 24 months. Using the retrospective method, the loan balance is the accumulated value of the initial loan less the accumulated value of the premiums paid to date:

$$\begin{aligned} B_{24} &= 20,000(1.01)^{24} - 300s_{\overline{24}|1\%} \\ &= 25,394.69297 - 300 \frac{1.01^{24} - 1}{0.01} \\ &= 17,302.65351 \end{aligned}$$

The interest part of the 25th payment is the monthly effective interest rate times the loan balance at time 24 months:

$$I_{25} = \frac{i^{(12)}}{12} B_{24} = 0.01 \times 17,302.65351 = 173.0265$$

Solution 27

D Present value of increasing perpetuity-due



Let's split the perpetuity-due into two parts: a level perpetuity-due of \$45 at the beginning of each year forever, and an increasing perpetuity-due that pays \$5 today and increases by \$5 each year forever. The present value of an increasing perpetuity-due is:

$$(Ia)_{\infty}| = \lim_{n \rightarrow \infty} (Ia)_{n}| = \lim_{n \rightarrow \infty} \frac{\ddot{a}_{n}| - nv^n}{d} = \frac{1/d}{d} = \frac{1}{d^2}$$

The present value of both parts is:

$$\frac{45}{d} + \frac{5}{d^2} = 3,423.96$$

$$45d + 5 = 3,423.96d^2$$

$$3,423.96d^2 - 45d - 5 = 0$$

Using the quadratic equation, we solve for d :

$$d = \frac{45 \pm \sqrt{(-45)^2 - 4(3,423.96)(-5)}}{2(3,423.96)}$$

$$d = 0.04535$$

We ignore the negative solution since it doesn't make sense with interest rates. Now that we have d , we can determine the annual effective interest rate i :

$$1 + i = (1 - 0.04535)^{-1}$$

$$i = 0.0475$$

Solution 28**E** Reinvestment of bond coupons and bond yield 

Let's work in semiannual effective periods and define the bond variables first:

$$F = C = 1,000$$

$$n = 15 \times 2 = 30$$

$$i = 0.12 / 2 = 0.06$$

$$r = 0.10 / 2 = 0.05$$

$$\text{coupon} = 0.05 \times 1,000 = 50$$

$$a_{\overline{30}|6\%} = \frac{1 - (1.06)^{-30}}{0.06} = 13.76483$$

The price of the bond is:

$$P = 50a_{\overline{30}|6\%} + 1,000(1.06)^{-30} = 862.35169$$

Alternatively, using the BA 35, we press [2nd][CMR], 1,000 [FV], 30 [N], 50 [PMT], 6 [%i], [CPT][PV], and the result is 862.35169. Using the BA II Plus, we press [2nd][CLR TVM], -1,050 [FV], 30 [N], -50 [PMT], 6 [I/Y], [CPT][PV], and we get the same result.

The investor borrows this amount so that she can buy the bond. She will owe the interest and principal in a lump sum at time 15 years:

$$862.35169(1.09)^{15} = 3,141.10090$$

The investor reinvests the bond coupons at an semiannual effective interest rate of $0.05/2 = 0.025$. The accumulated value of these coupons at time 15 years is:

$$50s_{\overline{30}|2.5\%} = 50 \left[\frac{(1.025)^{30} - 1}{0.025} \right] = 2,195.13516$$

At time 15 years, the bond will mature for \$1,000, and she will have the accumulated value of the reinvested coupons. The value of her bond investment at time 15 years is:

$$1,000 + 2,195.13516 = 3,195.13516$$

The investor's net gain at time 15 years is:

$$3,195.13516 - 3,141.10090 = 54.03426$$

Solution 29**E** Short call maximum gain 

The maximum gain from a short call is the future value of the premium:

$$\text{Short call profit} = -\text{Max}[0, S_T - K] + FV(\text{premium})$$

Solution 30**A** Compound increasing annuity-immediate

Claims cost increase at a rate of 10% per year. The first claim will occur in one year and it will include one increase of 10%. There will be 25 payments, the last of which will occur at time 25 years, and it will include 25 increases of 10%. We set up the equation of value and solve for X , the unknown average claim cost of today:

$$273,978.56 = \frac{1.10 \times X}{1.07} + \frac{1.10^2 \times X}{1.07^2} + \frac{1.10^3 \times X}{1.07^3} + \dots + \frac{1.10^{25} \times X}{1.07^{25}}$$

$$273,978.56 = X \left(\frac{1.10}{1.07} \right) \left[1 + \left(\frac{1.10}{1.07} \right)^2 + \left(\frac{1.10}{1.07} \right)^3 + \dots + \left(\frac{1.10}{1.07} \right)^{24} \right]$$

$$273,978.56 = X \left(\frac{1.10}{1.07} \right) \left[\frac{1 - (1.10/1.07)^{25}}{1 - (1.10/1.07)} \right]$$

$$36.53047X = 273,978.56$$

$$X = 7,500.00$$

Alternatively, we can use the formula for a compound increasing annuity-immediate. Since this formula requires the first payment to be \$1, the factor to apply to the formula is $X(1.10)$. The adjusted interest rate j is:

$$j = \frac{0.07 - 0.10}{1.10} = -0.027273$$

The formula for the present value of a compound increasing annuity-immediate is:

$$\frac{1}{1+e} a_{\overline{n}|j} = \frac{1}{1+e} \left[\frac{1 - (1+j)^{-n}}{j} \right]$$

The formula works even if j is negative. (The formula does not work if j is zero.) We have:

$$273,978.56 = X(1.10) \frac{1}{1.10} \left[\frac{1 - [1 + (-0.027273)]^{-25}}{-0.027273} \right]$$

$$36.53047X = 273,978.56$$

$$X = 7,500.00$$

Solution 31**B** Varying payment perpetuity-due

Let's split this payment series into three parts:

Part I: \$1 at time 0, \$2 at time 1, \$3 at time 2, and so on, up to \$15 at time 14

Part II: \$14 at time 15, \$13 at time 16, and so on, down to \$5 at time 24

Part III: \$5 at time 25, \$5 at time 26, and so on, forever

Part I has 15 payments. The present value at time 0 of Part I is:

$$\ddot{a}_{\overline{15}|} = \frac{1 - (1.06)^{-15}}{0.06/1.06} = 10.294984$$

$$(I\ddot{a})_{\overline{15}|} = \frac{\ddot{a}_{\overline{15}|} - 15(1.06)^{-15}}{0.06/1.06} = \frac{10.294984 - 15(1.06)^{-15}}{0.056604} = 71.302808$$

Part II has 10 payments and they can be split into two subparts:

Subpart A: \$10 at time 15, \$9 at time 16, and so on, down to \$1 at time 24

Subpart B: \$4 at time 15, \$4 at time 16, and so on, level to \$4 at time 24

The present value at time 15 of Subpart A is:

$$a_{\overline{10}|} = \frac{1 - 1.06^{-10}}{0.06} = 7.360087$$

$$(D\ddot{a})_{\overline{10}|} = \frac{10 - a_{\overline{10}|}}{0.06/1.06} = \frac{10 - 7.360087}{0.056604} = 46.638462$$

The present value at time 15 of Subpart B is:

$$4\ddot{a}_{\overline{10}|} = 4 \times \frac{1 - 1.06^{-10}}{0.06/1.06} = 4 \times 7.801692 = 31.206769$$

Part III is a perpetuity. The present value at time 25 of Part III is:

$$5\ddot{a}_{\infty} = \frac{5}{0.06/1.06} = 88.333333$$

Bringing all the parts back together, and discounting the present values of Parts II and III back to time 0, we have:

$$71.302808 + (1.06)^{-15} [46.638462 + 31.206769] + (1.06)^{-25} [88.333333] = 124.37$$

Solution 32

D Short put profit diagram



The profit diagram matches the graph of a short put, which is choice D.

The bear spread's profit diagram looks like:

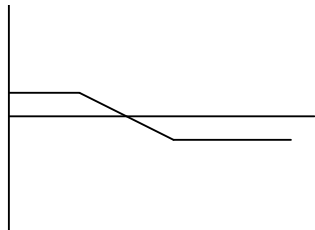

The short call's profit diagram looks like:

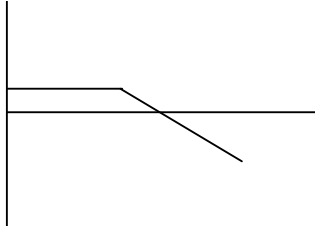

The long call's profit diagram looks like:

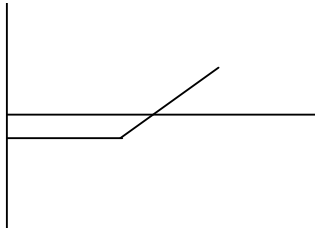

The long put's profit diagram looks like:

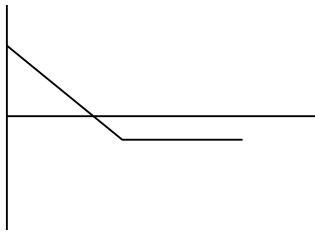

Solution 33

B Simple interest and force of interest



Fund X has a constant annual effective discount rate. This implies that the corresponding annual effective interest rate and the continuously compounded interest rate are also constant:

$$d = 0.08$$

$$i = \frac{0.08}{1 - 0.08} = 0.086957$$

$$\delta = \ln(1 + 0.086957) = 0.083382$$

Fund Y has a constant annual simple interest rate. This implies that the force of interest varies over time. Under simple interest, the accumulated value at time t is:

$$AV(t) = AV(0)[1 + it]$$

The derivative of this function with respect to t is:

$$AV'(t) = AV(0)i$$

The force of interest is then:

$$\delta_t = \frac{AV'(t)}{AV(t)} = \frac{AV(0)i}{AV(0)[1 + it]} = \frac{i}{1 + it}$$

We need to determine the accumulated value of Fund Y at time 6 years. Since Fund Y was started at time 4 years, it only has 2 years to accumulate its initial deposit. We are given that the force of interest after 2 years in Fund Y is equivalent to the force of interest after 6 years in Fund X. The force of interest in Fund X remains constant at 0.083382, so we can solve for the force of interest after 2 years in Fund Y:

$$\begin{aligned}\delta_t &= \frac{i}{1+it} \\ 0.083382 &= \frac{i}{1+2i} \\ 0.083382(1+2i) &= i \\ i &= 0.100070\end{aligned}$$

We can now determine the accumulated value of the initial deposit in Fund Y after 2 years:

$$AV(2) = AV(0)(1+2i) = 250(1+2 \times 0.100070) = 300.03$$

Solution 34

E Bond and loan



Sarah has \$15,000 and she borrows \$5,000 to buy a \$20,000 par value bond. She uses a portion of the bond's coupon payments to pay the interest due on the loan. Both the bond and the loan have monthly payments, so the net cash flows that Sarah receives over the 120 month period are the bond coupon payments less the loan interest payments. We are given that the bond coupon payments are \$150 each month. The monthly loan interest payment is:

$$I_t = 5,000 \times 0.01 = 50$$

Therefore, Sarah receives a net cash flow of \$100 each month over 120 months. She initially invested \$15,000. She receives a net \$15,000 at time 10 years since she receives \$20,000 when the bond matures, but she owes \$5,000 to repay the loan at time 10 years.

Using the BA II Plus, we can determine her monthly effective yield. Press 120 [N], 100 [PMT], -15,000 [PV], 15,000 [FV], and then [CPT][I/Y], and the result is 0.6667%. This is Sarah's monthly effective yield. To determine the annual effective yield, we have:

$$1.006667^{12} - 1 = 0.0830$$

Solution 35**B** Put-call parity

Martha receives the call premium when she sells the call and she pays the put premium when she buys the put. We are not provided with the call or put premium, but we don't actually need to know what they are in order to answer this question when we consider put-call parity:

$$C(K, T) + PV(K) = S_0 + P(K, T)$$

$$C(K, T) + 52.50 \times 1.1025^{-0.5} = 50.00 + P(K, T)$$

$$C(K, T) + 50.00 = 50.00 + P(K, T)$$

$$C_0(K, T) = P_0(K, T)$$

Martha's net cost is:

$$C(K, T) - P(K, T) = 0$$